

113/3623N PZ

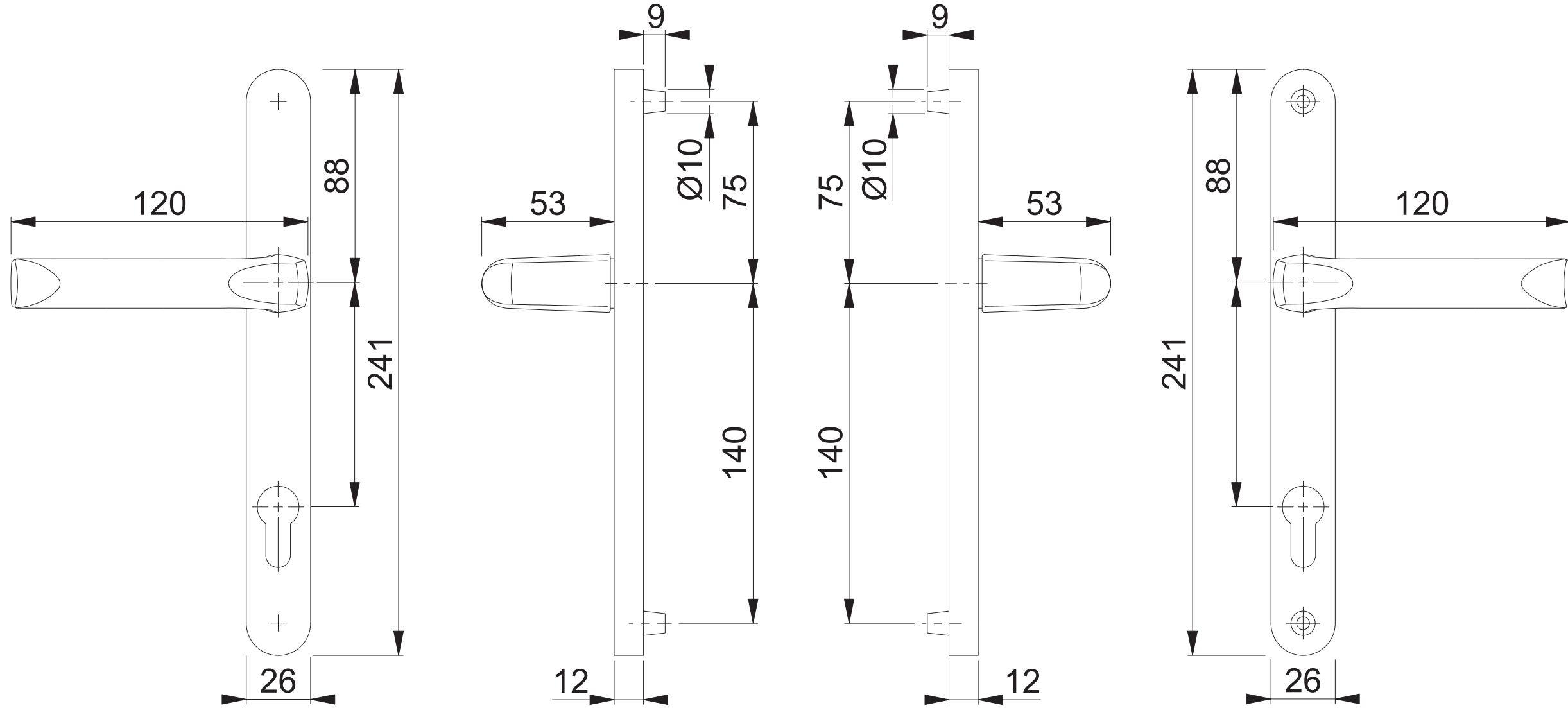

Maßstab 1:2	Name Hauser G.	Datum 22.07.2005	Zeichnungsnummer c0022480z002	G3.00	HOPPE
----------------	-------------------	---------------------	----------------------------------	-------	--------------