

E1140Z/353K PZ

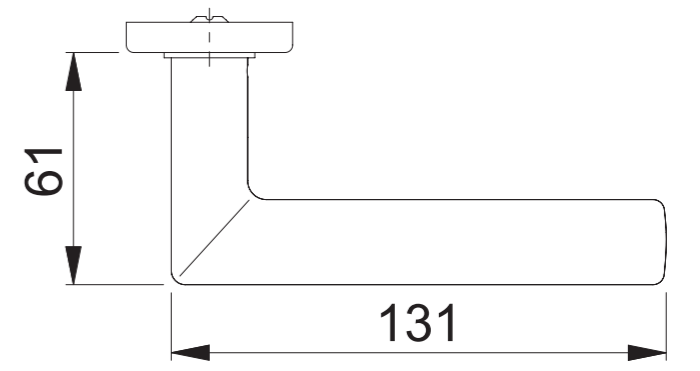
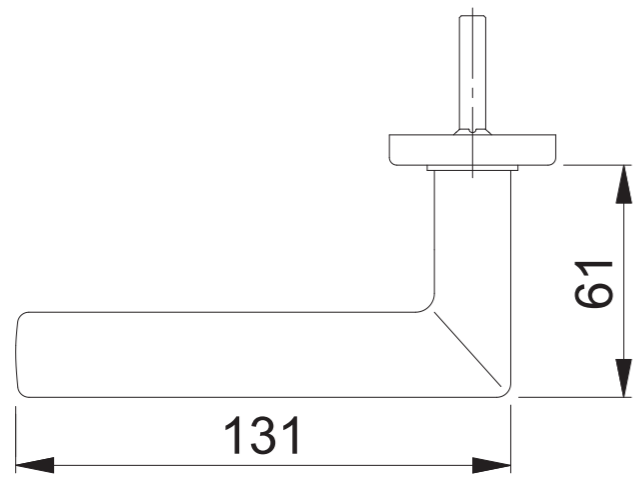
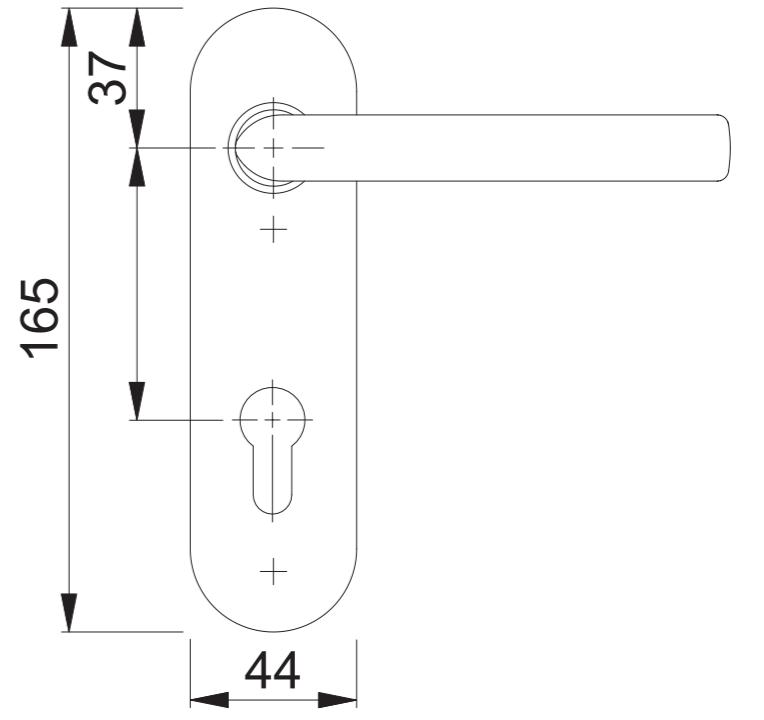
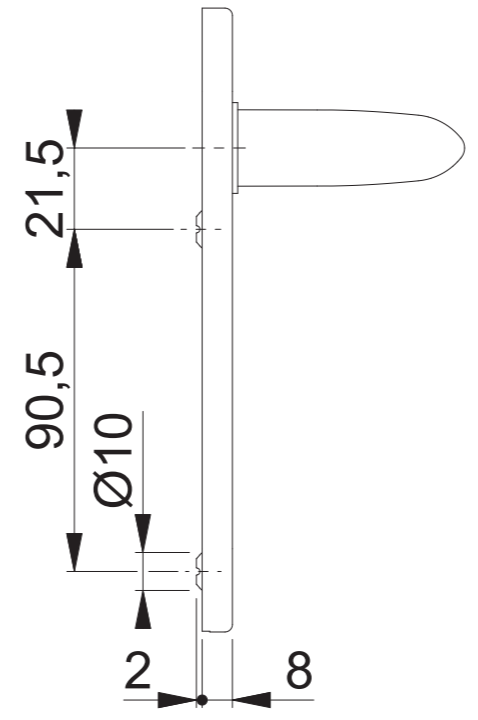
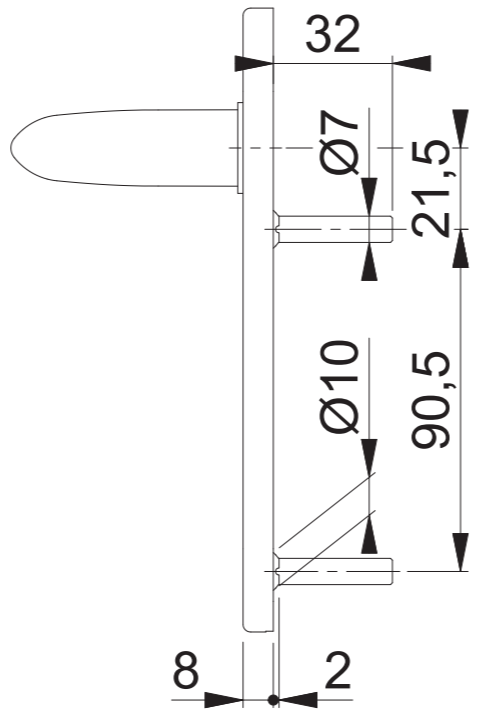
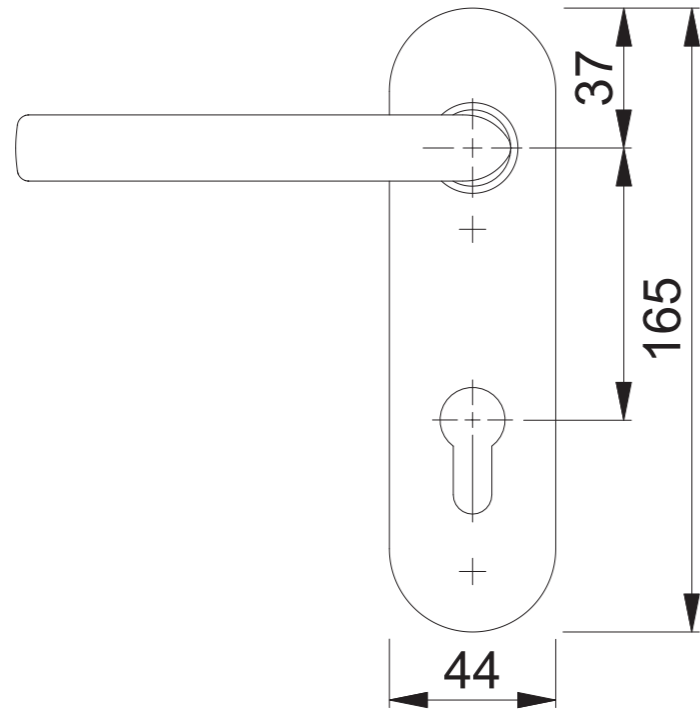

Maßstab 1:2	Name Scholz	Datum 26.07.2012	Zeichnungsnummer QU=c0022876z003 A300	HOPPE
----------------	----------------	---------------------	--	--------------