

E1140Z/353K SK/OL (KSK27/EOL28)

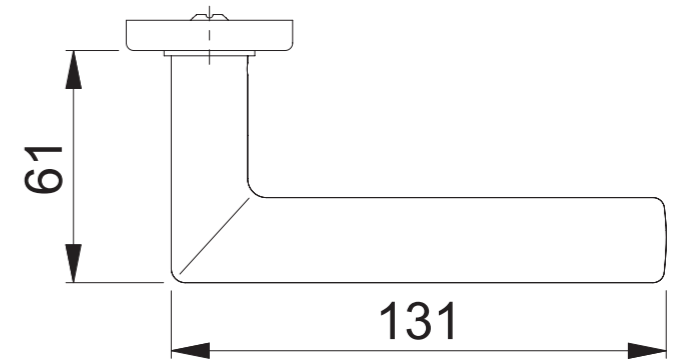
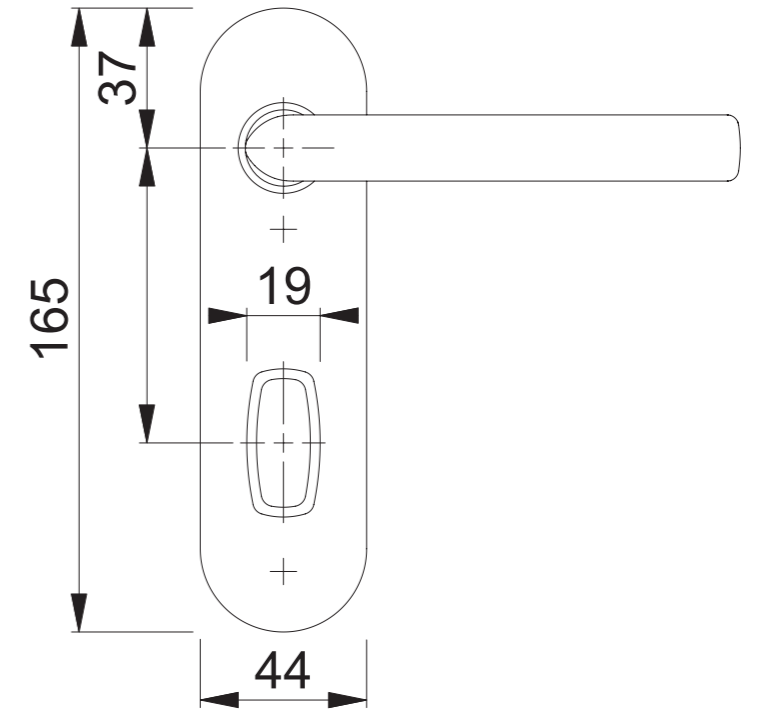
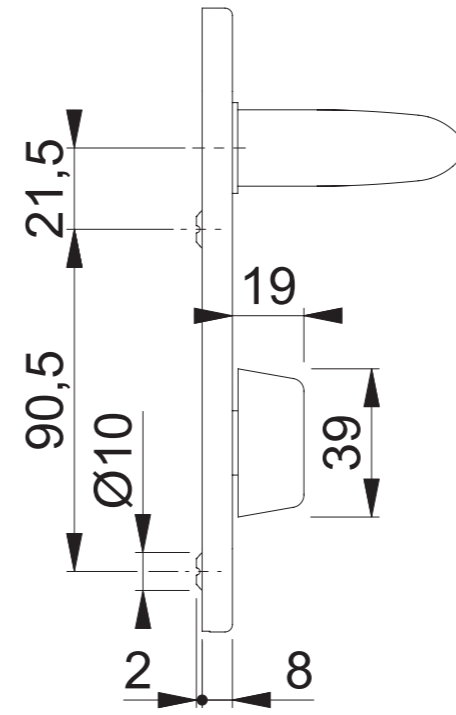
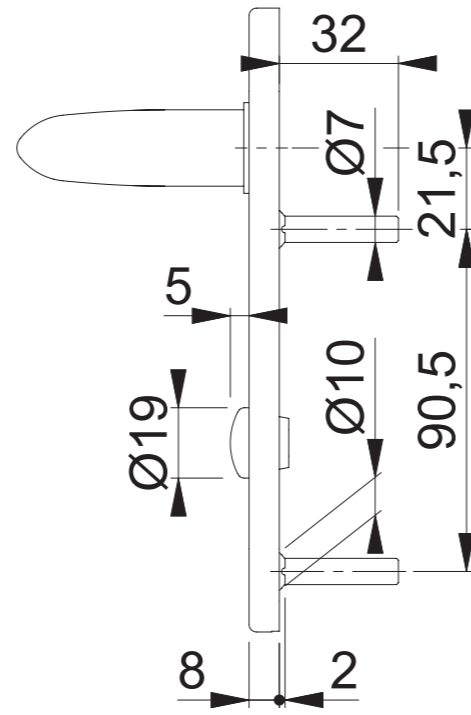
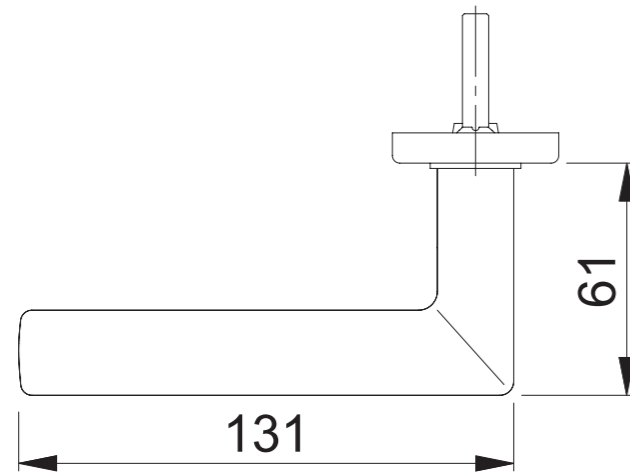
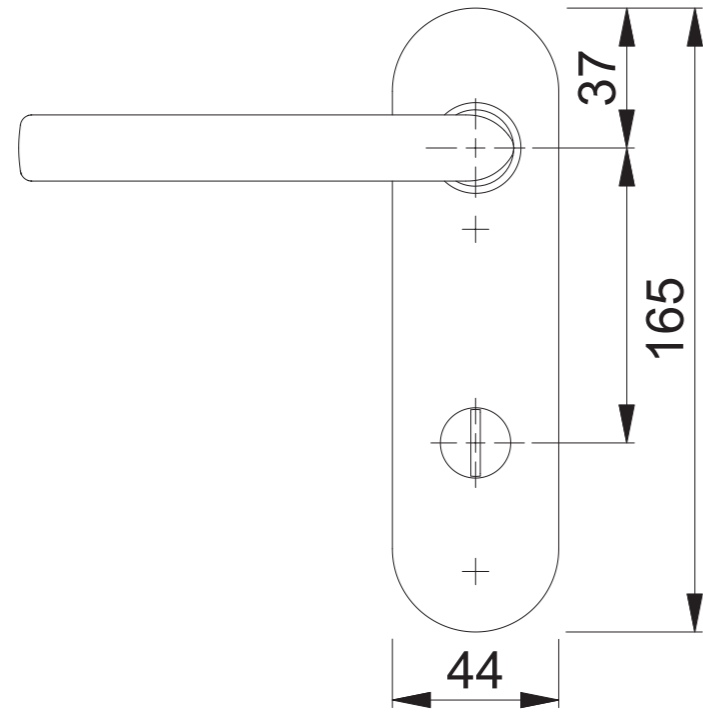

Maßstab 1:2	Name Scholz	Datum 26.07.2012	Zeichnungsnummer c0022876z003	A300	HOPPE
----------------	----------------	---------------------	----------------------------------	------	--------------