

E138/353H RWSK/OL (RWKSK27/EOL28-3)

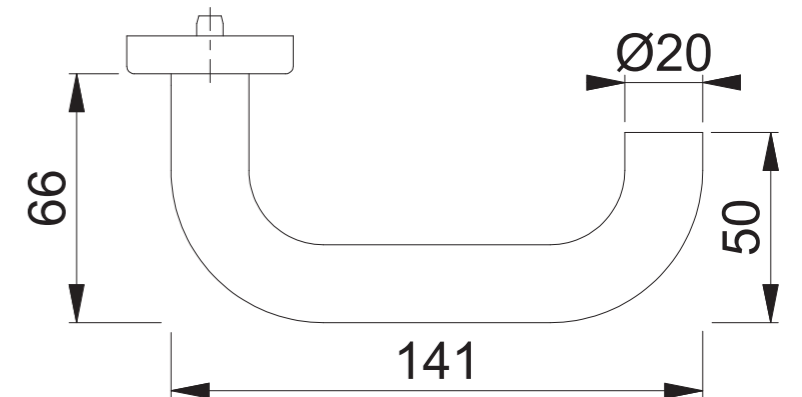

Maßstab	Name	Datum	Zeichnungsnummer	
1:2	Bauer	14.04.2016	c0023244z005	A3 00

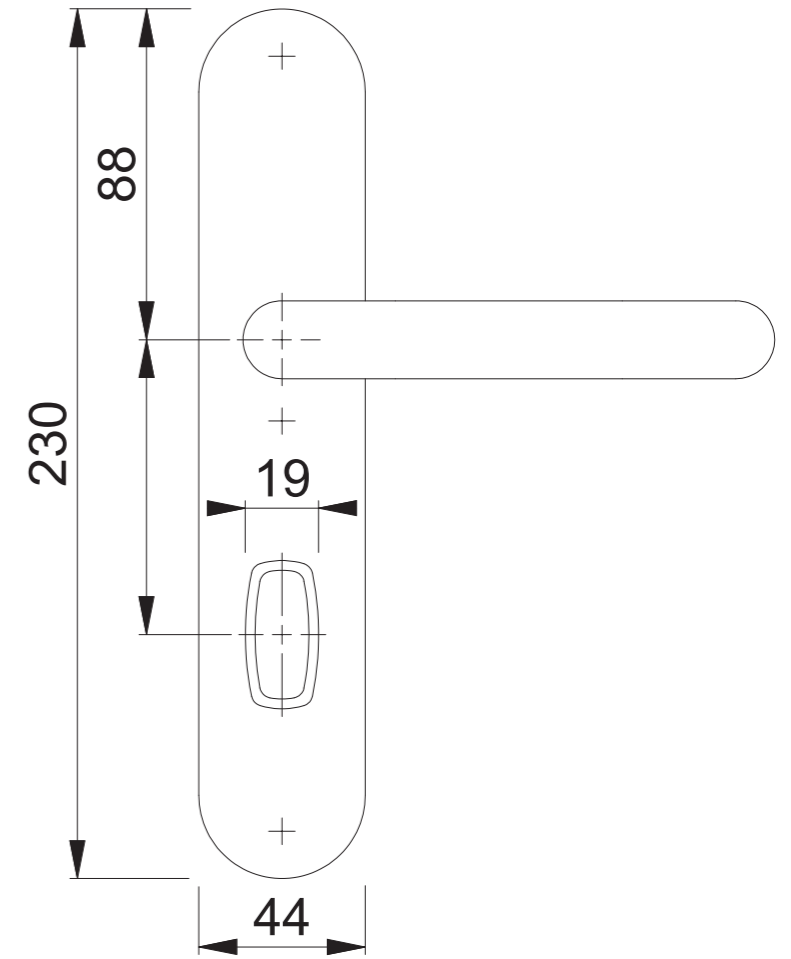
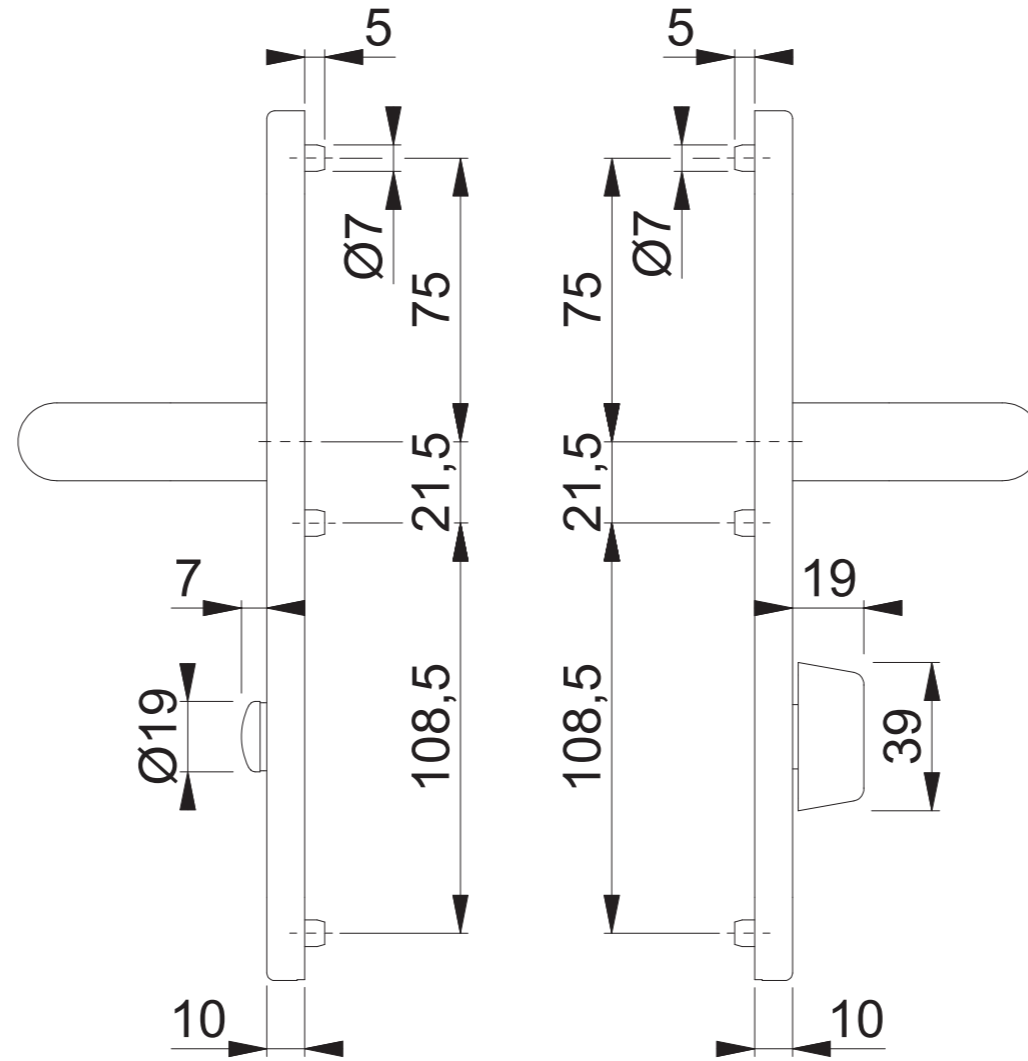
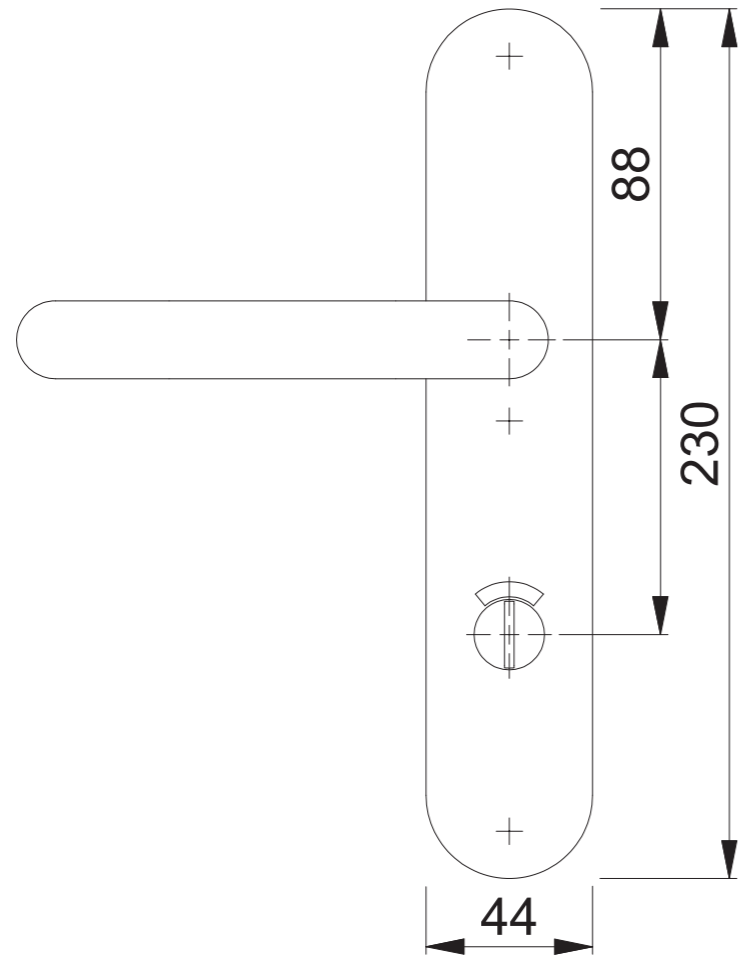
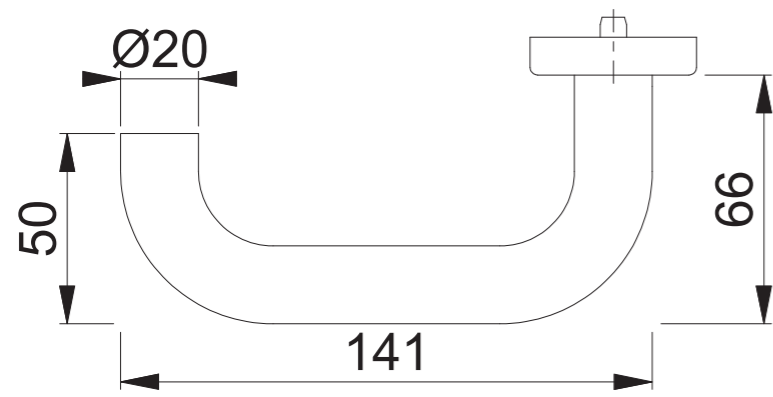